

# LFX-SM SERIES Outdoor Lighting

LFX-SM-10-30W-30K-TR  
LFX-SM-10-30W-40K-TR  
LFX-SM-10-30W-50K-TR

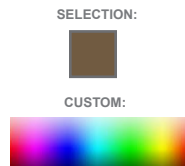
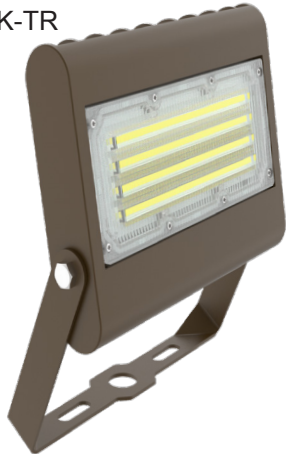

Customer Name: \_\_\_\_\_

Project Name: \_\_\_\_\_

Note: \_\_\_\_\_

Type: \_\_\_\_\_

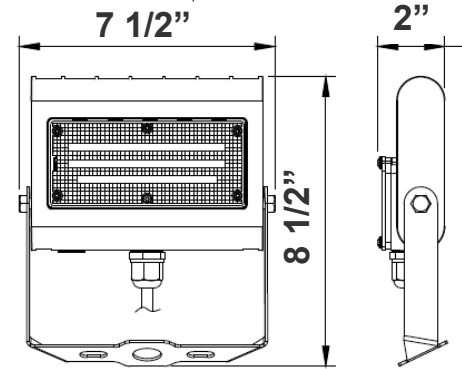

8 1/2"(H) x 7 1/2"(W) x 2"(D)

Ideal for general site lighting, alleys, loading docks, doorway, pathway, and parking areas.

## Features

- DLC Premium & LED High-Lumen Flood lights
- Solid State Lighting Technology for Long Life
- No Maintenance Needed and High-Efficiency
- 70,000 Hours Rated Life
- 7-Year Warranty
- Optic Lens Type: III
- Multi-Power - The Switch is on the Bottom of the Fixture

## Technical Specifications

### Electrical:

- Voltage: 120~277V AC/50~60 Hz
- Wattage: Selectable Wattages (10W/ 15W/ 20W/ 30W)
- Power Factor: >0.9
- Efficacy: 130 LPW

### Mechanical:

- Die-cast Aluminum Housing with Powder Coat Finish (Dark Bronze and White Finish)
- LED: Philips Lumileds Luxeon 2835 High Flux LED
- Solid State Lighting technology for long life, no Maintenance needed and High-Efficiency
- High Conductive Aluminum LED Board
- 270° Adjustable Yoke Mount
- IP Rating: IP65
- Operating Temperature: -40°F to 104°F
- Suitable for Wet Locations

### Lighting:

- Dimming: 0~10V Dimmable
- Optic Lens Type: III
- Cord type: 13" #18 AWG stranded wires
- Total Lumens: 4080LM Max.
- Color Temperature: 3000K/ 4000K/ 5000K
- Color Rendering Index: ≥ 82
- Beam Angle: 120°X 90°

### Applications:

- Ideal for general site lighting, alleys, loading docks, doorway, pathway and parking areas.
- Replace existing HID flood lights/ wall packs

### Other Models:

- 50W | 6700LM | LFX-MD-15-50W-30K-TR
- 50W | 6700LM | LFX-MD-15-50W-40K-TR
- 50W | 6700LM | LFX-MD-15-50W-50K-TR



## Photometrics: LFX-SM-10-30W-TR

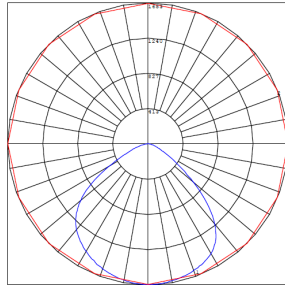
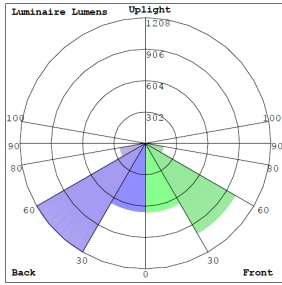

BUG Rating: B2-U0-G1

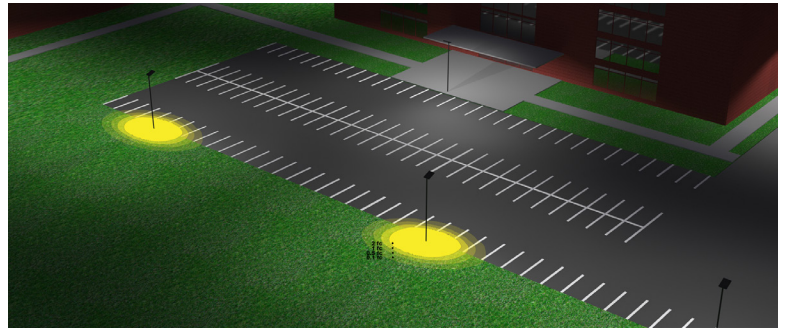

Area 40'x 50' Mounting Height: 20'

## Other Views:

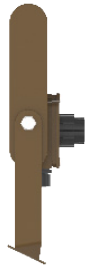

Side View



Front View

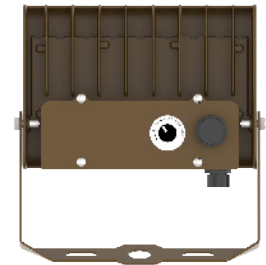

Back View

## Performance Table: LFX-SM-10-30W-TR

MODEL NO.	Wattage	Voltage	Lumens	Color Temp.	BUG Rating	LPW
LFX-SM-10-30W-30K-TR	10W	120~277V	1300LM	3000K 4000K 5000K	B2-U0-G1	130
			1350LM			
			1410LM			
			1950LM			
LFX-SM-10-30W-40K-TR	15W		2000LM			
			2080LM			
			2520LM			
			2600LM			
LFX-SM-10-30W-50K-TR	20W		2680LM			
			3880LM			
			3950LM			
			4080LM			
LFX-SM-10-30W-50K-TR	30W	2680LM				
		3880LM				
		3950LM				
		4080LM				

## Sample Ordering

Model	Size	Min.Wattage	Max.Wattage	Color Temp.	Mount
LFX	SM	10	30W		TR

30K = 3000K  
40K = 4000K  
50K = 5000K

## Color Options: Custom Color Available

Black Silver White Dark Bronze Green Red Yellow  
Default color

